

SÉURA®

MIRROR OVERLAY KIT INSTALLATION INSTRUCTIONS

Specifications

measurements are in millimeters

Size	TV Size	Model No.	A	B	C	D	E	F	G	H	I
1016 (w) x 711 (h)	32"	S-4028-32-OV.1-B	1016	711	966	661	705	399	813	89*	89
1143 (w) x 787 (h)	37"	S-4531-37-OV.1-B	1143	787	1093	737	828	467	940	89*	89
1270 (w) x 864 (h)	42"	S-5034-42-OV.1-B	1270	864	1220	814	937	529	1067	89*	89
1346 (w) x 914 (h)	46"	S-5336-46-OV.1-B	1346	914	1296	864	1030	583	1169	89*	89
1575 (w) x 1067 (h)	52"	S-6242-52-OV.1-B	1575	1067	1525	1017	1160	655	1321	89*	89
1905 (w) x 1270 (h)	65"	S-7550-65-OV.1-B	1905	1270	1855	1220	1437	810	1651	89*	89

* The overlay kit alone is 89 mm in depth. When surface mounted, the off-wall depth is 89 mm plus the additional depth of the TV and wall bracket.

**SURFACE MOUNT
FRONT VIEW**

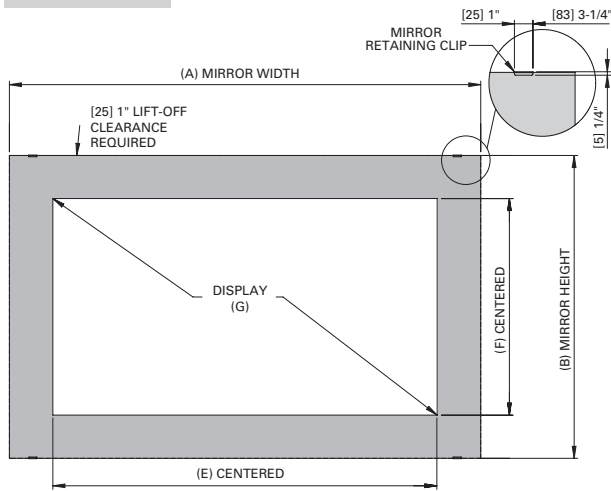

**SURFACE MOUNT
SIDE VIEW**

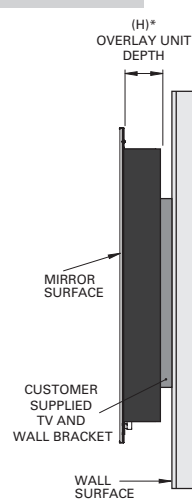

**SURFACE MOUNT
3D VIEW**

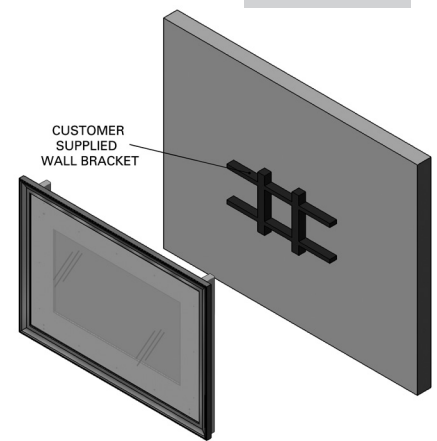

**RECESSED MOUNT
FRONT VIEW**

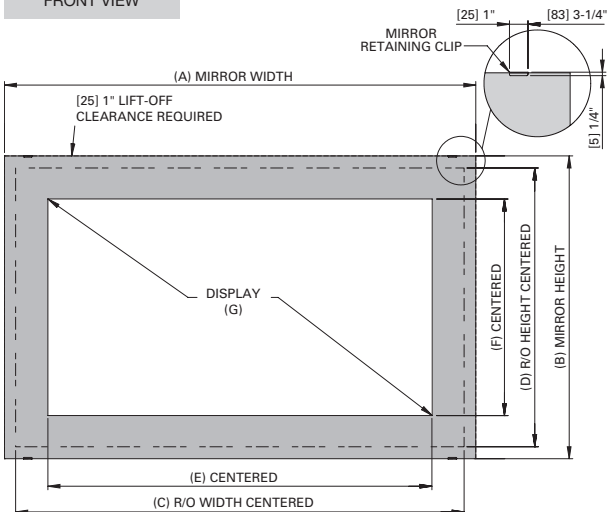

**RECESSED MOUNT
SIDE VIEW**

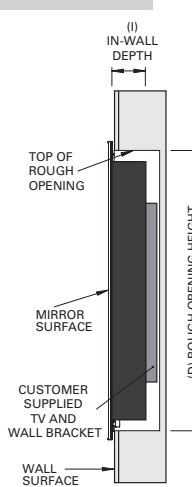

**RECESSED MOUNT
3D VIEW**

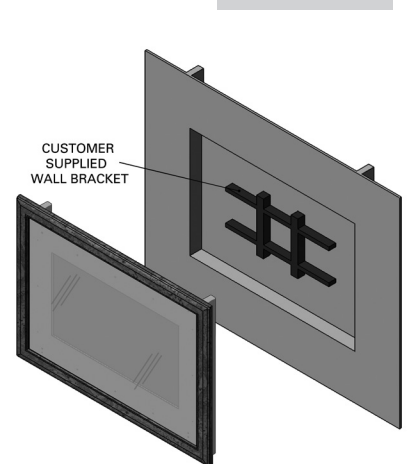

INSTRUCTIONS

- 1) Remove the overlay kit from packaging and place on a clean and flat surface, glass side down.
- 2) Loosen all six **tightening knobs** and open the **adjustable TV mounting brackets** to the largest setting.
- 3) Move **nylon straps** to the outside of the overlay kit.
- 4) Place the **customer-supplied TV** inside the overlay kit, face down.
- 5) Align TV screen with the **viewing window** of the overlay kit.
- 6) Slide the **adjustable TV mounting brackets** to snugly fit the TV housing and tighten all six **tightening knobs**.
- 7) Using the **D-rings**, firmly tighten the **nylon straps**.
- 8) Make all necessary A/V and power connections.
- 9) Mount the TV overlay kit to the wall using the customer-supplied mounting bracket.

REAR VIEW

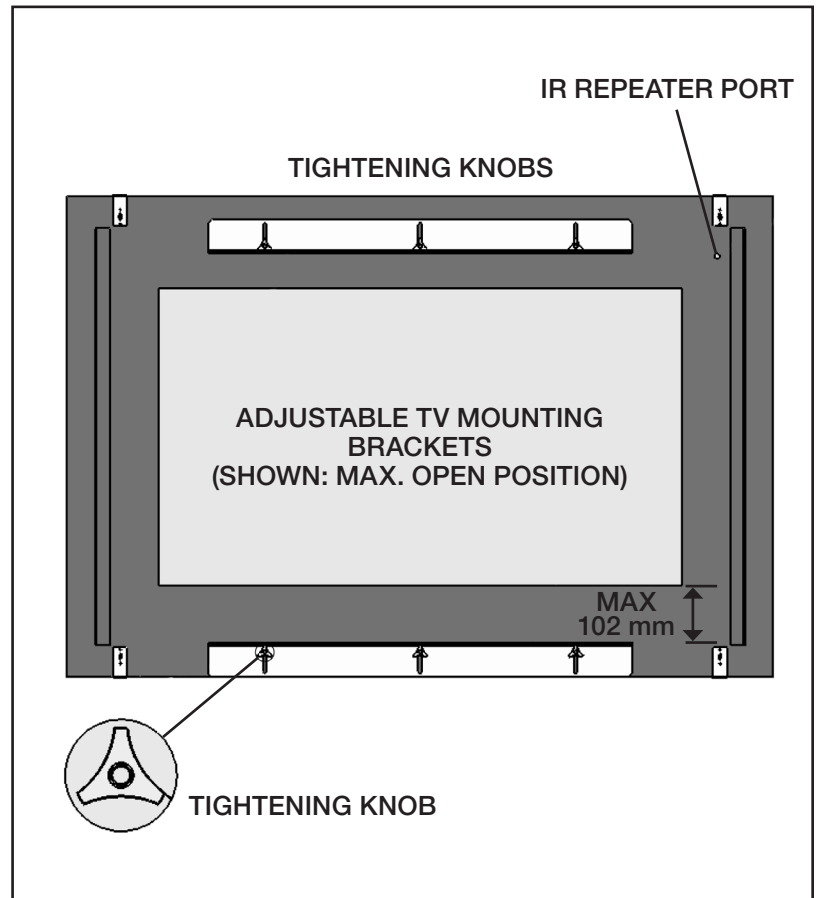

INSTALLATION VIEW

